

## PLANTA LAYOUT

### PLANTA BAIXA

#### IMPORTANTE:

DEVIDO A VARIAÇÃO DE **ESQUADRO** DO IMÓVEL, PODEM HAVER DIVERGÊNCIAS DE CENTÍMETROS NAS MEDIDAS.

VER MAIS:





# PLANTA HUMANIZADA

PLANTA BAIXA

**IMPORTANTE:**

DEVIDO A VARIAÇÃO DE **ESQUADRO** DO IMÓVEL, PODEM HAVER DIVERGÊNCIAS DE CENTÍMETROS NAS MEDIDAS.

VER MAIS:



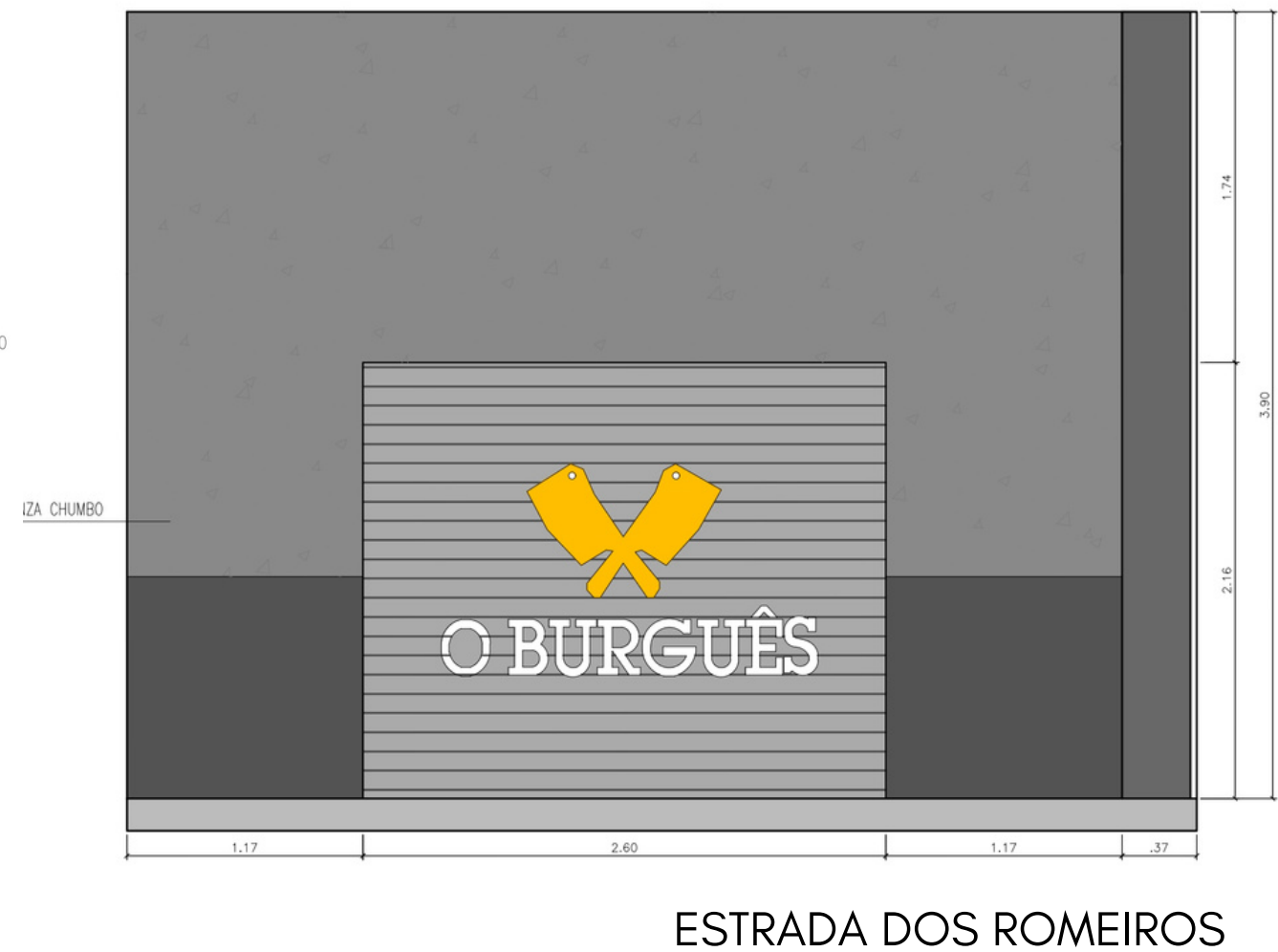

## ESTUDO DE FACHADA

PLANTA BAIXA

**IMPORTANTE:**

DEVIDO A VARIAÇÃO DE **ESQUADRO** DO IMÓVEL, PODEM HAVER DIVERGÊNCIAS DE CENTÍMETROS NAS MEDIDAS.

VER MAIS:





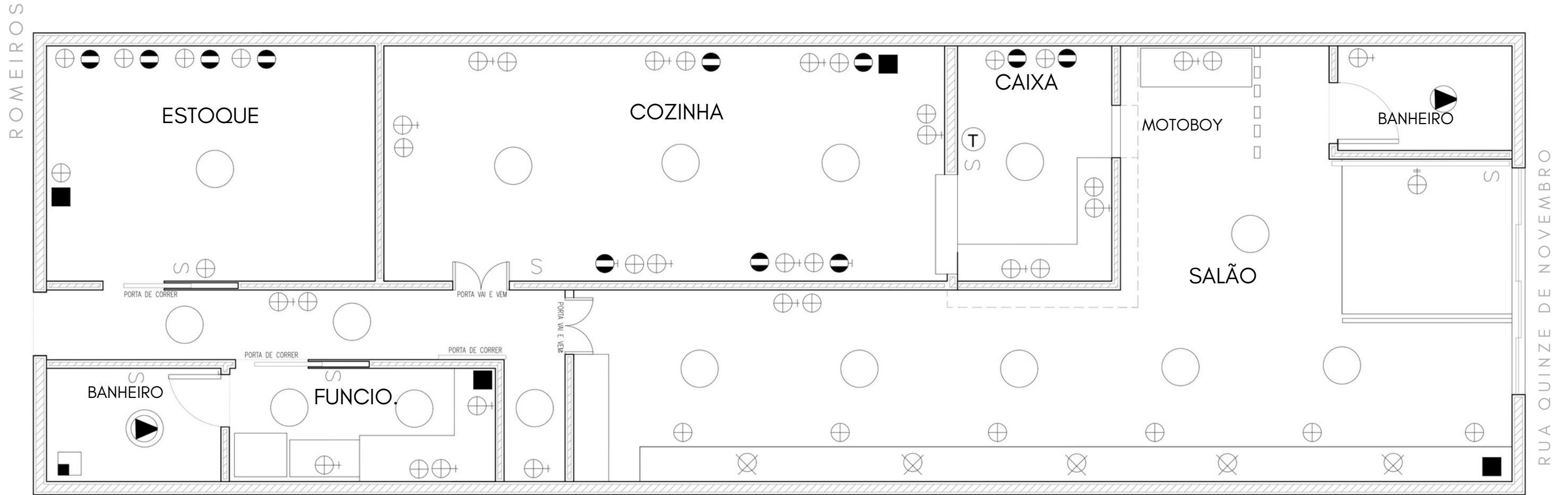

- |   |                     |                       |                          |
|---|---------------------|-----------------------|--------------------------|
| ○ PONTO DE LUZ                          | S INTERRUPTOR       | ⦿ TOMADA MÉDIA-220V   | ⊙ ACIONADOR DA CAMPAINHA |
| ▲ PONTO DE LUZ COM ACENDIMENTO AUTO.    | ⊕ TOMADA BAIXA-110V | ▽ PONTO DE TELEFONE   | ⌂ CAMPAINHA DE TIMBRE    |
| ☐ C.A. CENTRAL DE ALARME JUNTO AO TETO. | ⊕ TOMADA MÉDIA-110V | ▼ PONTO DE INTERNET   | ⦿ ARANDELA BAIXA         |
|   | ⊕ TOMADA ALTA-110V  | ■ PONTO DE FORÇA ALTO | ⊗ ARANDELA ALTA          |
|   | ⦿ TOMADA BAIXA-220V | ☐ CAIXA DE PASSAGEM   | Ⓣ TECLADO DE ALARME      |

## PLANTA ELÉTRICA

PLANTA BAIXA

**IMPORTANTE:**

DEVIDO A VARIAÇÃO DE **ESQUADRO** DO IMÓVEL, PODEM HAVER DIVERGÊNCIAS DE CENTÍMETROS NAS MEDIDAS.

VER MAIS:





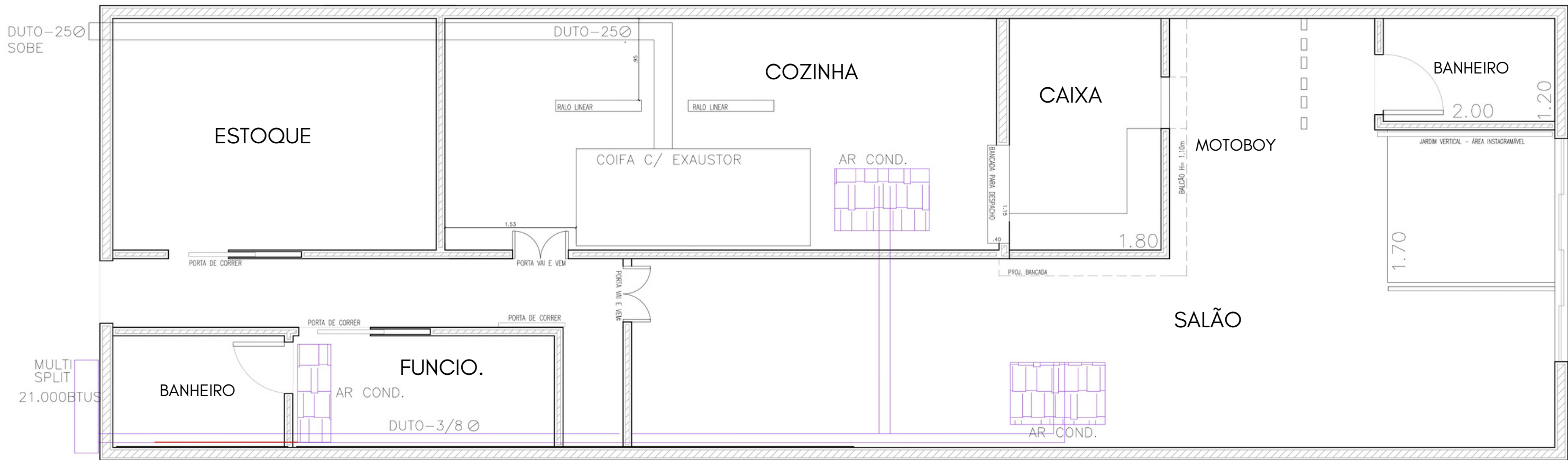

## PLANTA AR-CONDICIONADO E COIFA

PLANTA BAIXA

DET. COIFA:

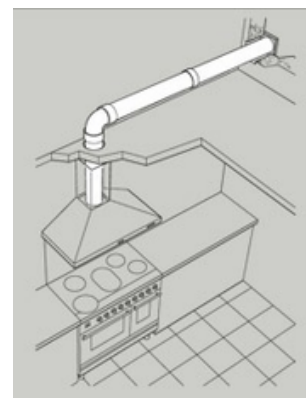

DET. AR-CONDICIONADO 1:



DET. AR-CONDICIONADO 2:

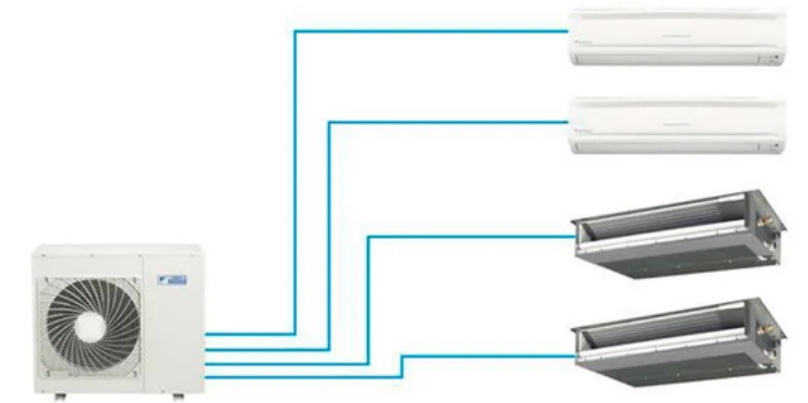

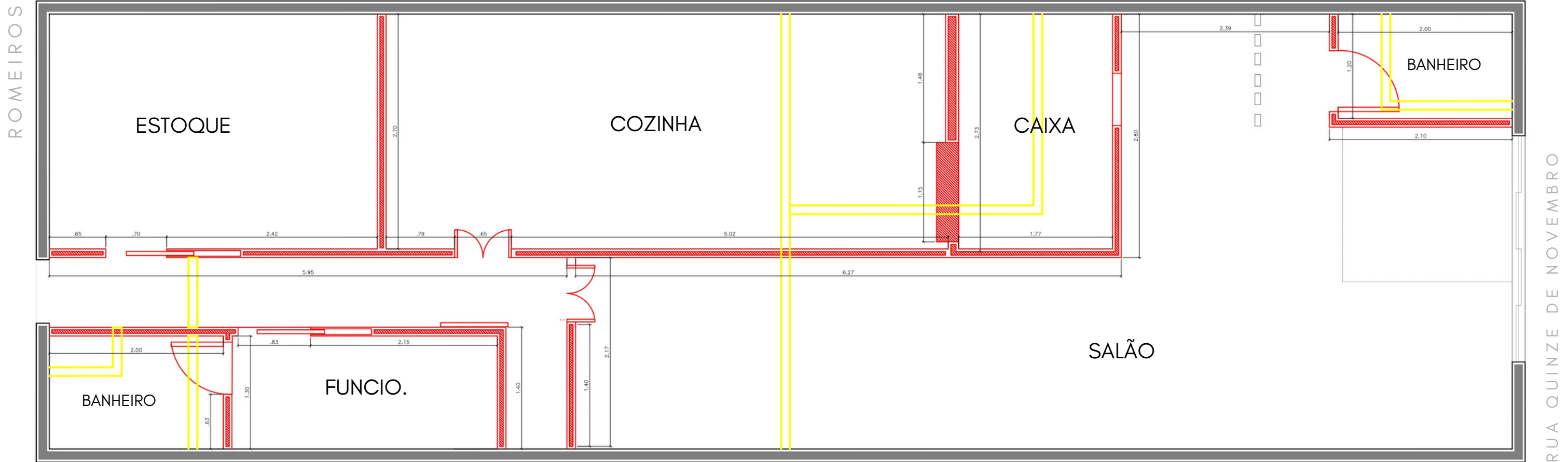

## A DEMOLIR E A CONSTRUIR

PLANTA BAIXA

**LEGENDA:**

- A CONSTRUIR
- A DEMOLIR

**IMPORTANTE:**

DEVIDO A VARIAÇÃO DE **ESQUADRO** DO IMÓVEL, PODEM HAVER DIVERGÊNCIAS DE CENTÍMETROS NAS MEDIDAS.

VER MAIS:



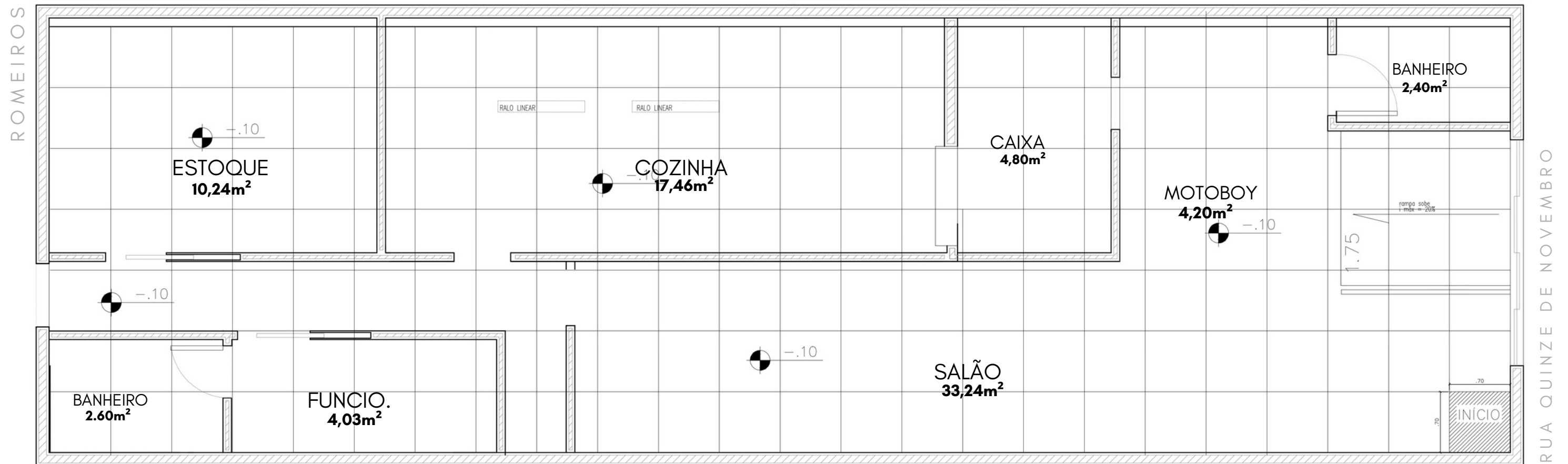

## PAGINAÇÃO DE PISO

PLANTA BAIXA

### ESPECIFICAÇÕES:

**COZINHA/ESTOQUE:** CERÂMICO BRANCO 70x70cm.

**DEMAIS CÔMODOS:** CERÂMICO INTERNO CIMENTO QUEIMADO 72x72cm.

### IMPORTANTE:

DEVIDO A VARIAÇÃO DE **ESQUADRO** DO IMÓVEL, PODEM HAVER DIVERGÊNCIAS DE CENTÍMETROS NAS MEDIDAS.

VER MAIS:





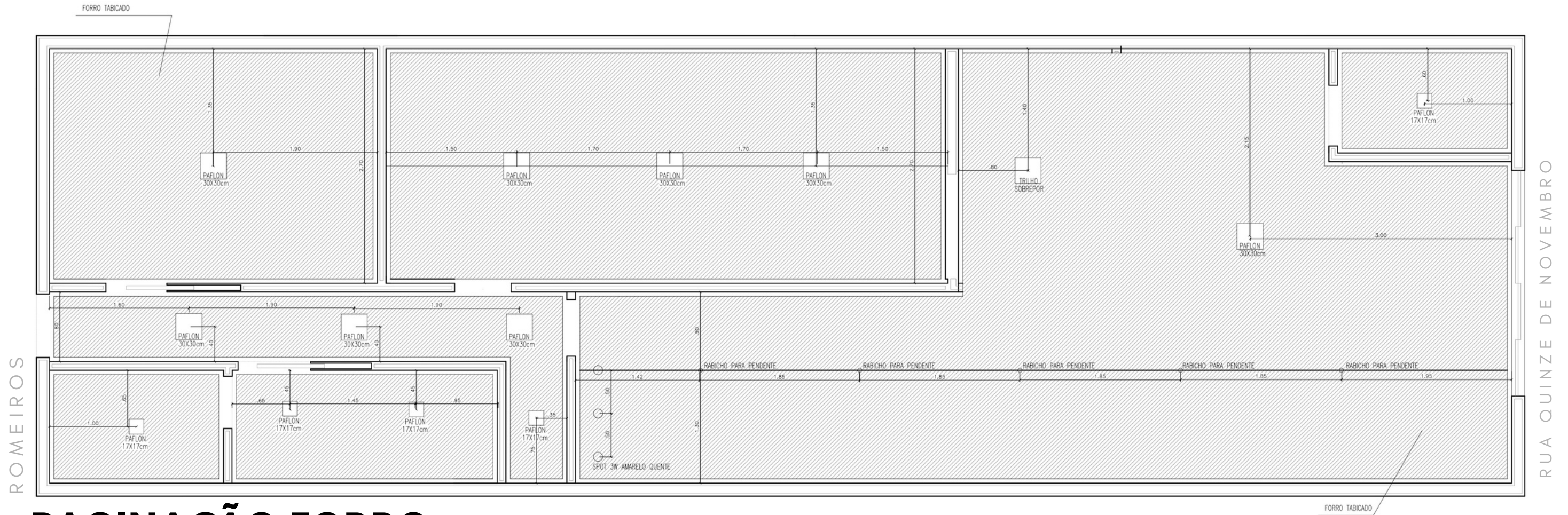

**PAGINAÇÃO FORRO**  
PLANTA BAIXA

**ESPECIFICAÇÕES:**  
GESSO ACARTONADO .

**IMPORTANTE:**

DEVIDO A VARIAÇÃO DE **ESQUADRO** DO IMÓVEL, PODEM HAVER DIVERGÊNCIAS DE CENTÍMETROS NAS MEDIDAS.

VER MAIS:





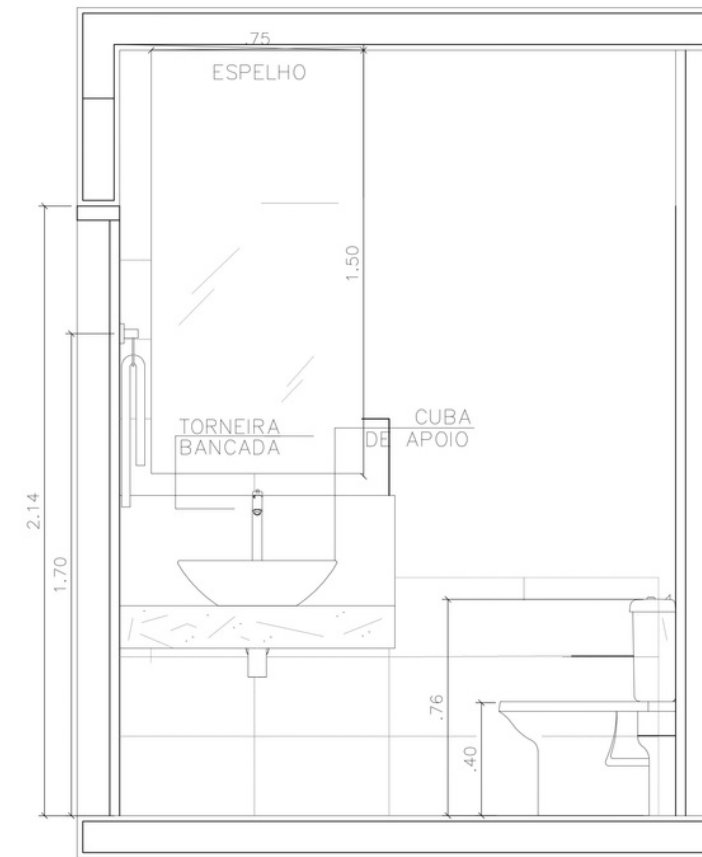
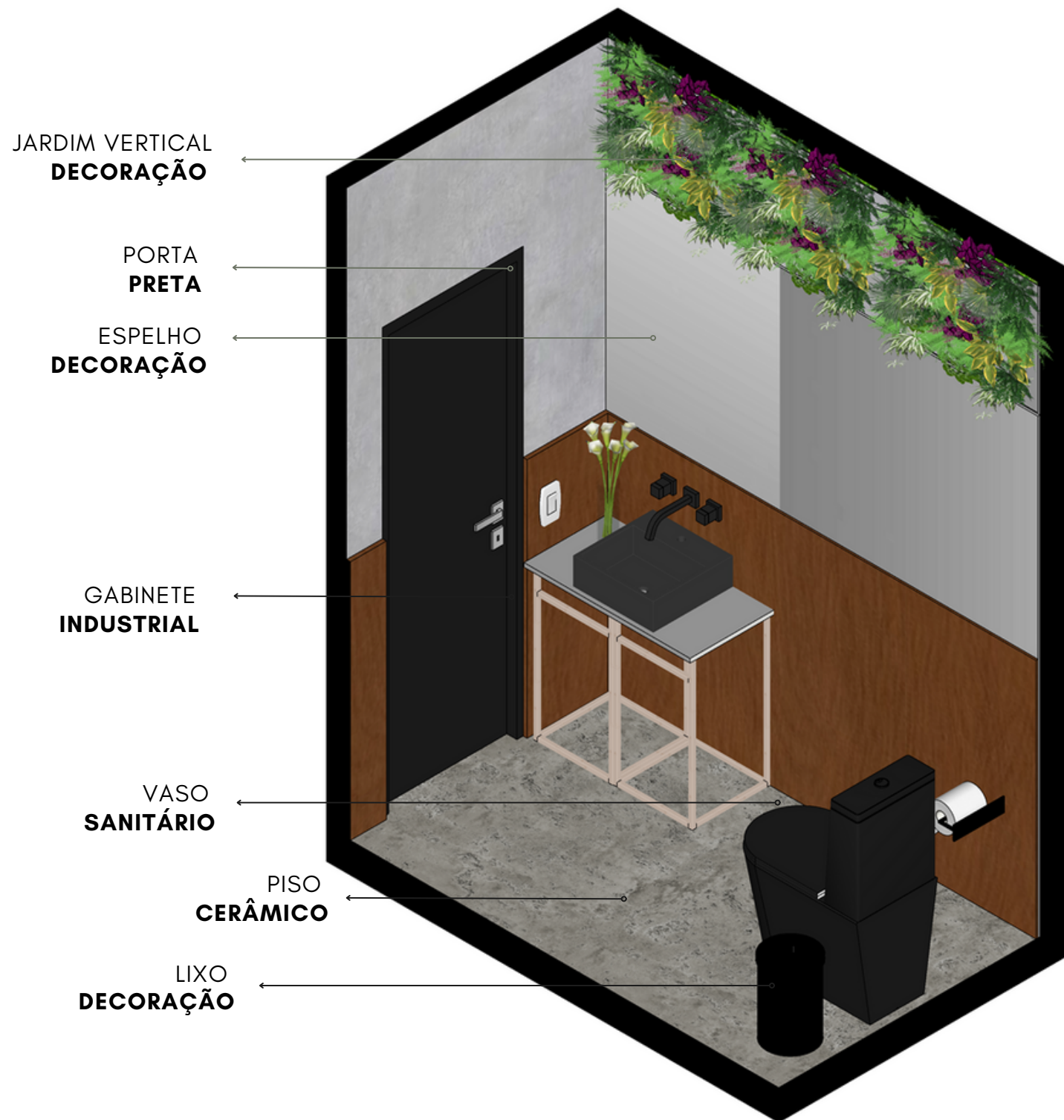

**CORTE AA**  
SALÃO.

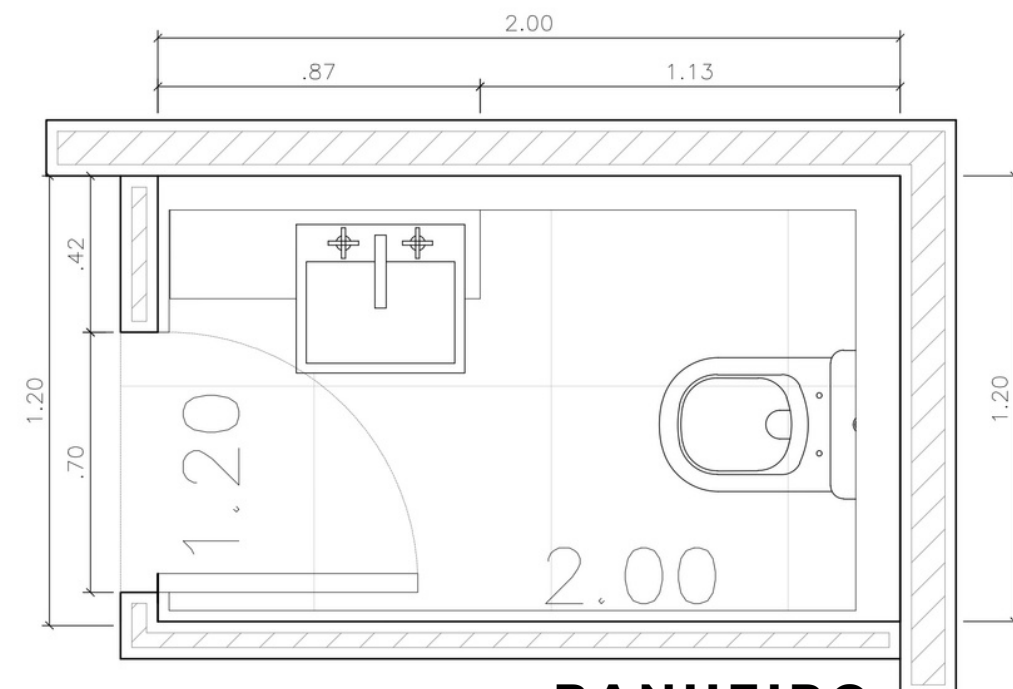

**BANHEIRO**  
SALÃO.





JARDIM VERTICAL  
DECORAÇÃO

ESPELHO  
DECORAÇÃO

CHUVEIRO  
ELÉTRICO

CUBA  
CERÂMICA

VASO  
SANITÁRIO

GABINETE  
INDUSTRIAL

BOX  
VIDRO TEMPERADO

PISO  
CERÂMICA

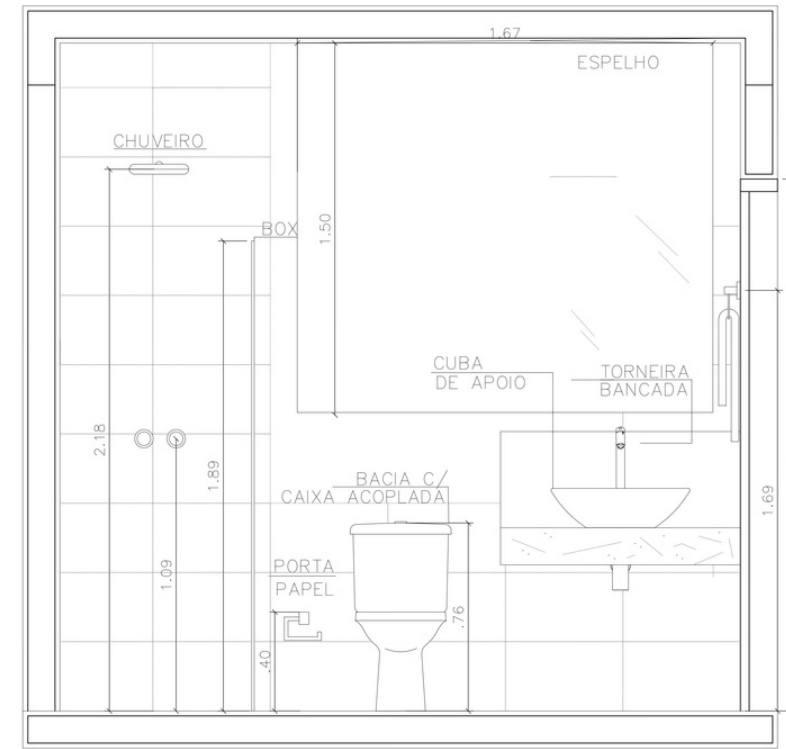

**CORTE AA**  
FUNCIONÁRIOS

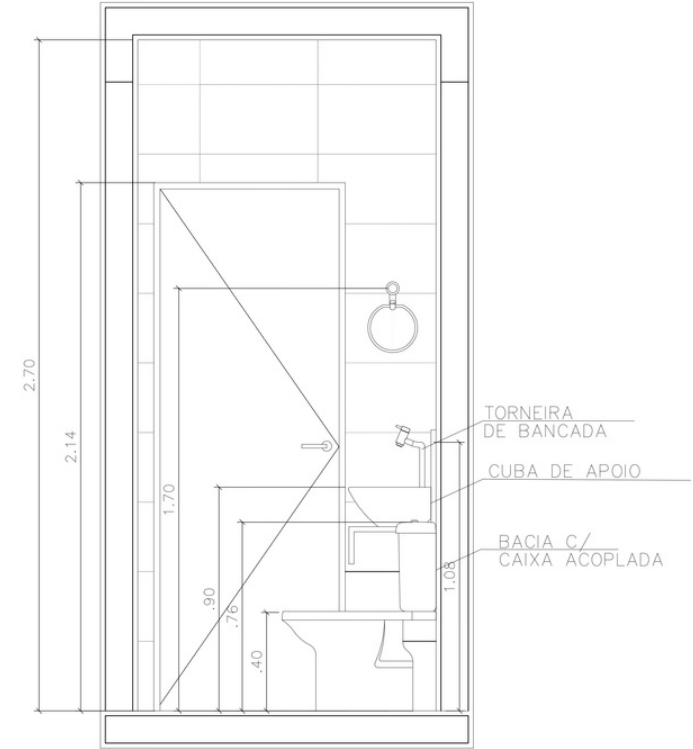

**CORTE BB**  
FUNCIONÁRIOS

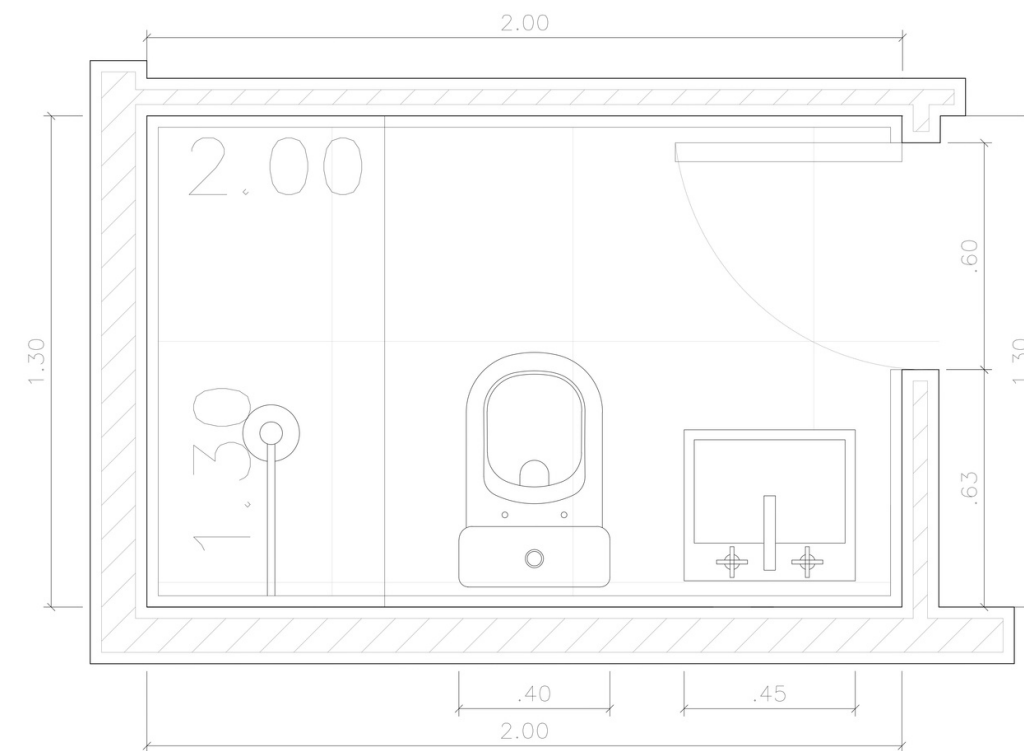

**BANHEIRO**  
FUNCIONÁRIOS





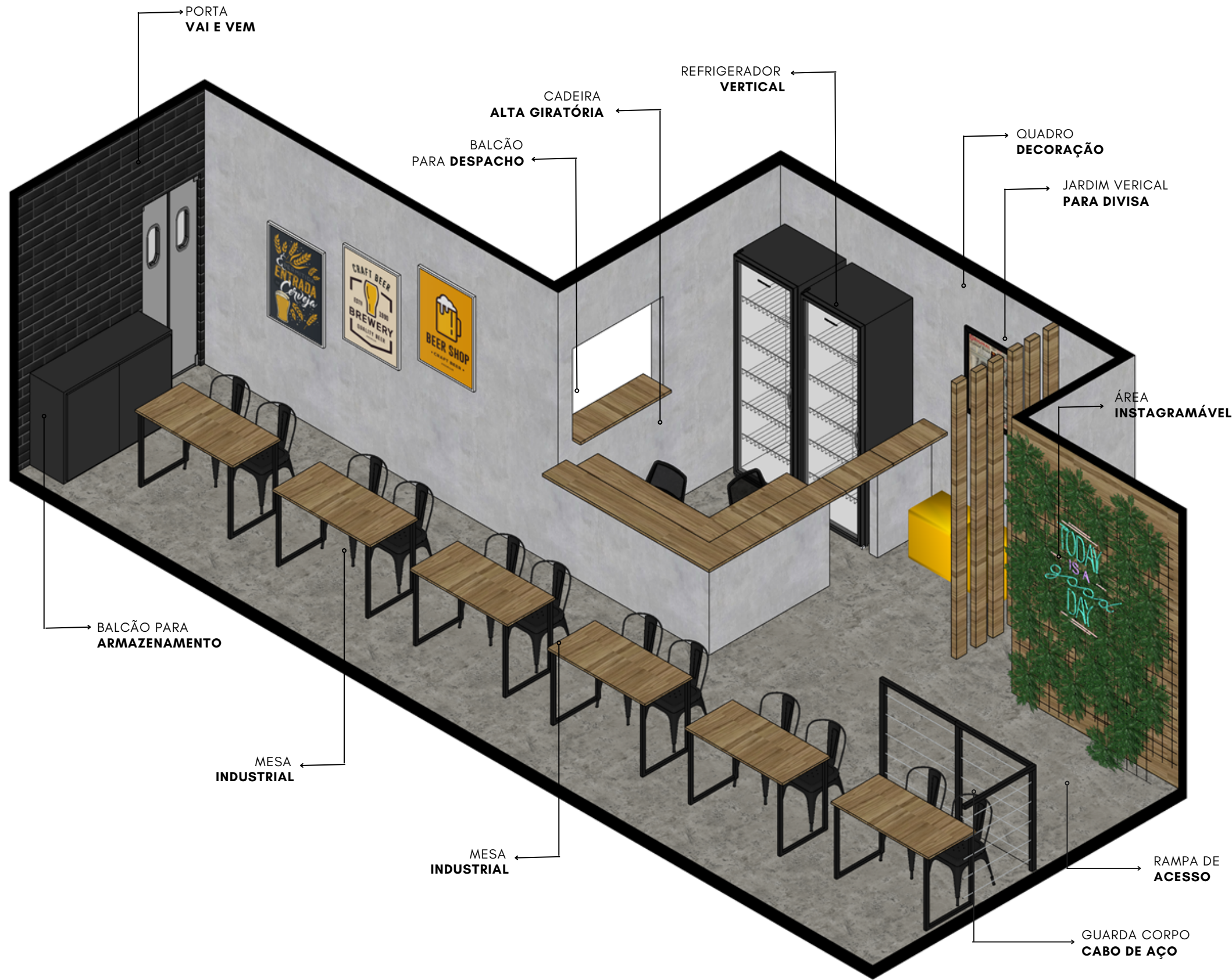



## DETALHAMENTO

